

PERFORMANCE DATA SHEET NEMA PREMIUM NR CAN NEMA 12 - 12

Catalogue #: MPP-57

HP	kW	Voltage	S.F. @ 60Hz	EFF.	P.F.	Frame	Design	L.R. Amps
40	29,84	575	1,25	94,1%	0,83	324T	B	232

60 Hz								
FLA							Code	F.L. RPM
208	230	416	460	480	575	600		
/	/	/	/	/	38,4	/	G	1780

50 Hz							
FLA			S.F. @ 50Hz	Efficiency	Power Factor	Code	F.L. RPM
190	380	415					
/	/	/	/	/	/	/	/

Wgt. Lbs	PH	Duty	Insul. Class	Amb.	Elevation	Temp. Rise° C
564	3	Cont.	F	40°C	1000M (3300 Ft)	55

% Efficiency		% Power Factor		Torque		Winding Resist. Ω	Safe Cold Start (Secs)
Full Load:	94,1%	Full Load:	0,83	Full Load Ft/Lbs	118,0		
3/4 Load:	94,6%	3/4 Load:	0,79	Locked Rotor %	160		
1/2 Load:	94,6%	1/2 Load:	0,70	Break Down %	245	0,28	20

Rotor Inertia Wk2 Lb-Ft2	Max Load Inertia Wk2 Lb-Ft2	Shaft Material	Frame Material	DE Bracket Type	ODE Bracket Type	Enclosure	NEMA Rating	Lead Wire Size
7,12	258	Standard	Cast Iron	Standard	Standard	TEFC	IP55	8AWG

Ball Bearings		Grease	Mount Type	Orientation	Paint	Sound Pressure @ 3FT	Sound Power
DE	ODE						
6312	6312	Mobil PolyrexEm	Rigid	Horizontal	Green	78	89

Inverter Duty. Motor meets MG1 parts 31.4.4.2	Constant Torque Range	Variable Torque Range	Constant HP RPM
	10:1	20:1	2700

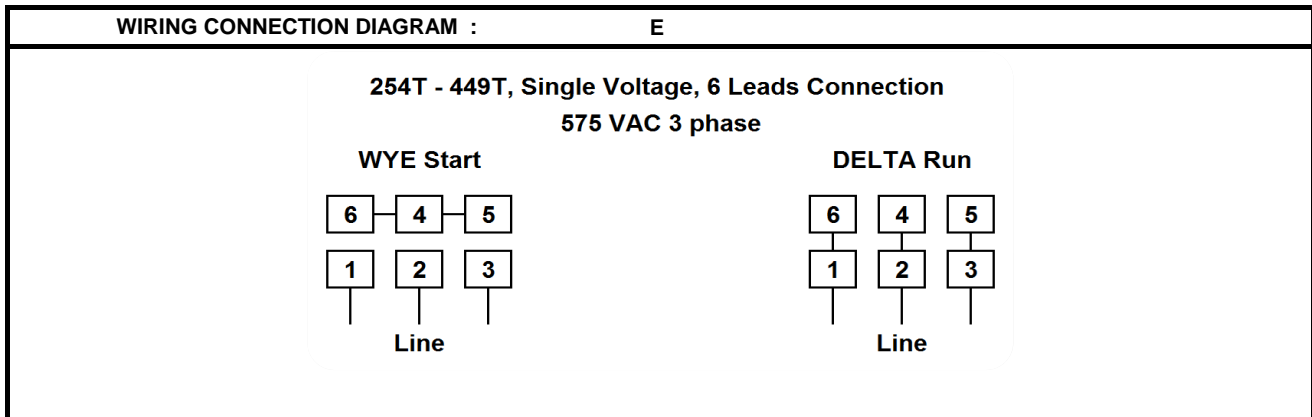

Date: 2020-02-27
 Customer: _____
 Contact: _____
 Submittee: J.C. Lavallée

Catalogue #: MPP-57

NEMA PREMIUM NR CAN NEMA 12 - 12										
HP	VAC	RPM	Enclosure	Frame	Frequency	Design	Poles	LR Code Letter	Insulation Class	Temp. Rise °C
40	575	1780	TEFC	324T	60	B	4	G	F	55
	0Hz	6Hz	15Hz	30Hz	45Hz	60Hz	75Hz	90Hz	105Hz	120Hz
Amps	38,4	38,4	38,4	38,4	38,4	38,4	38,4	38,4	38,4	38,4
RPM	0	178	445	890	1335	1780	2225	2670	3115	3560
Torq ft.lb	94,42	118,02	118,02	118,02	118,02	118,02	94,42	78,68	67,44	59,01
Peak Tq ft.lb	131,30	262,60	262,60	262,60	262,60	262,60	210,08	175,07	150,06	131,30
HP	0	4,0	10,0	20,0	30,0	40,0	40,0	40,0	40,0	40,0
	Locked Rotor	Pull-Up	Breakdown	Rated Load	Idle	Duty	S. F.	Ambient	Elevation	dBA @ 1M
Speed (RPM)	0,0	756	1440	1780	1800	Continuous	1,25	40°C	3300 ft	78
Current (Amps)	232,0	197,2	138,0	38,4	14,6	VFD Rating: Meets MG1 parts 31.4.4.2				
Torque (ft-lbs)	188,8	141,6	289,2	118,0	0,0	C.T.	10:1	V.T.	20:1	

Motor Speed Data

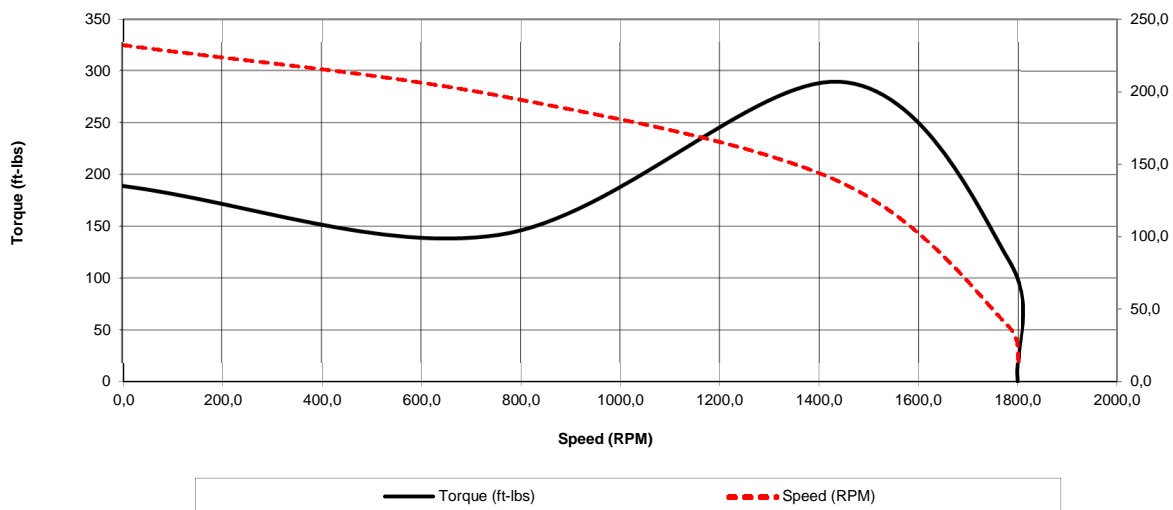

Motor Torque Capability vs RPM

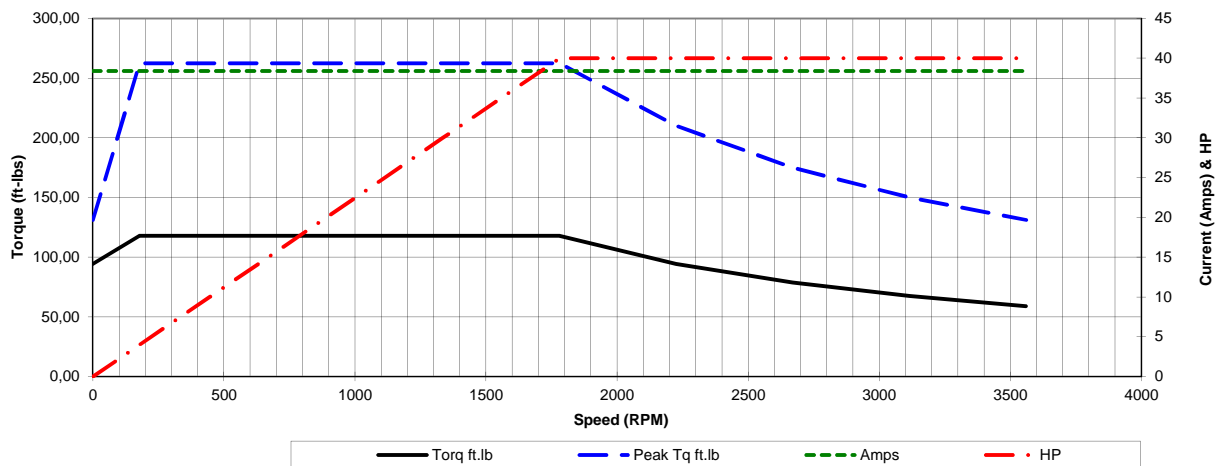



Date: 2020-02-27
 Customer: _____
 Contact: _____
 Submittee: J.C. Lavallée

Catalogue #: **MPP-57**

NEMA PREMIUM NR CAN NEMA 12 - 12										
HP	VAC	RPM	Enclosure	Frame	Frequency	Design	Poles	LR Code Letter	Insulation Class	Temp. Rise °C
40	575	1780	TEFC	324T	60	B	4	G	F	55
Load %	0%	25%	50%	75%	100%	125%	150%			
Amps	14,60	16,40	22,70	30,00	38,40	47,44	57,40			
Torq ft/lbs	0	29,21	58,64	88,22	118,02	148,11	178,50			
RPM	0	1795	1790	1785	1780	1775	1770			
Eff	0	90,63	94,60	94,60	94,10	94,10	94,10			
PF	0	50,4	70	79	83	83,9	83,2			
	Locked Rotor	Pull-Up	Breakdown	Rated Load	Idle	Duty	S. F.	Ambient	Elevation	dBA @ 1M
Speed (RPM)	0	756	1440	1780	1800	Continuous	1,25	40°C	3300 ft	78
Current (Amps)	232	197,2	138,0	38,4	14,6	VFD Rating: Meets MG1 parts 31.4.4.2				
Torque (ft-lbs)	188,84	141,63	289,16	118,02	0,0	C.T.	10:1	V.T.	20:1	

